

Colette
patterns



No.
IOI4
negroni



Three free pocket variations for this classic men's camp shirt, along with two alternate pocket flaps. Courtesy of colettepatterns.com

Pocket Instructions

All pieces include 3/8 inch seam allowances.

POINTED POCKET (PIECE M)

- 1 Follow the instructions included with the Negroni pattern for creating and attaching these pockets.
- 2 For pocket flaps, you may either use the flaps that come with the Negroni pattern (L), one of the alternate versions included here (R or S), or omit them.

DIVET POCKET (PIECES N AND O)

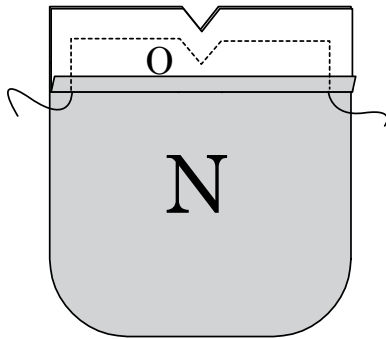

- 1 On divet pocket facing (O), with wrong side facing up, fold along the fold line and press.
- 2 With right sides together, stitch divet pocket facing (O) to divet pocket (N) along top and sides, pivoting at each corner.
- 3 Follow the instructions included with the Negroni pattern for turning in facing and edges.
- 4 Once pocket is ready to be attached, topstitch divet pocket (N) along the marked topstitching line, on the right side of each.
- 5 Attach the pockets as shown in the pattern booklet. Omit the pocket flaps, so that the divet will remain visible.

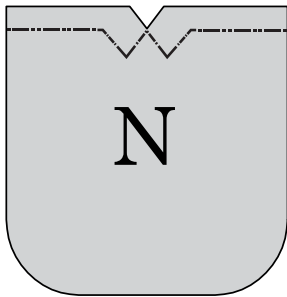

BOX PLEAT POCKET (PIECES P AND Q)

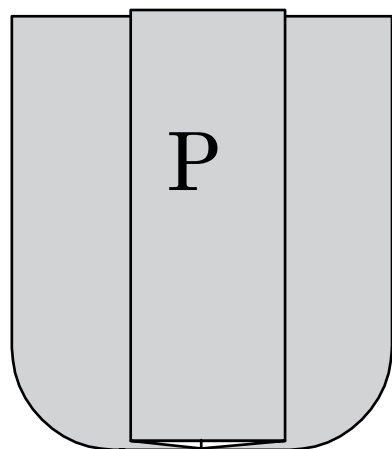
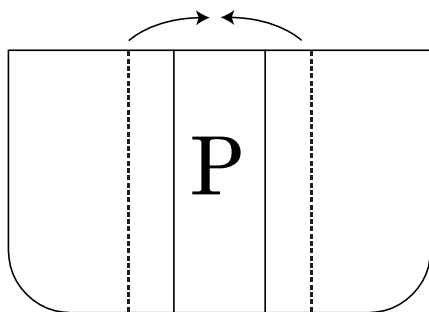

- 1 On box pleat pocket (P), bring dotted lines together with wrong sides facing each other. Stitch along dotted line.
- 2 On right side, press box pleat flat, folding along the solid lines to form a pleat.
- 3 On box pleat pocket facing (Q), with wrong side facing up, fold along the fold line and press.
- 4 With right sides together, stitch box pleat pocket facing (Q) to box pleat pocket (P) along top and sides, pivoting at each corner.
- 5 Follow the instructions included with the Negroni pattern to turn in facing and edges and attach
- 6 For pocket flaps, you may either use the flaps that come with the Negroni pattern (L), one of the alternate versions included here (R or S), or omit them.

Pocket Flaps

ASYMMETRICAL POCKET FLAP (PIECE R)

- 1 Follow the instructions included with the Negroni pattern for creating and attaching these pocket flaps. Adjust button placement to match the buttonhole.
- 2 These pocket flaps may be combined with any other pocket variation.

CURVED POCKET FLAP (PIECE S)

- 1 Follow the instructions included with the Negroni pattern for creating and attaching these pockets.
- 2 These pocket flaps may be combined with any other pocket variation.

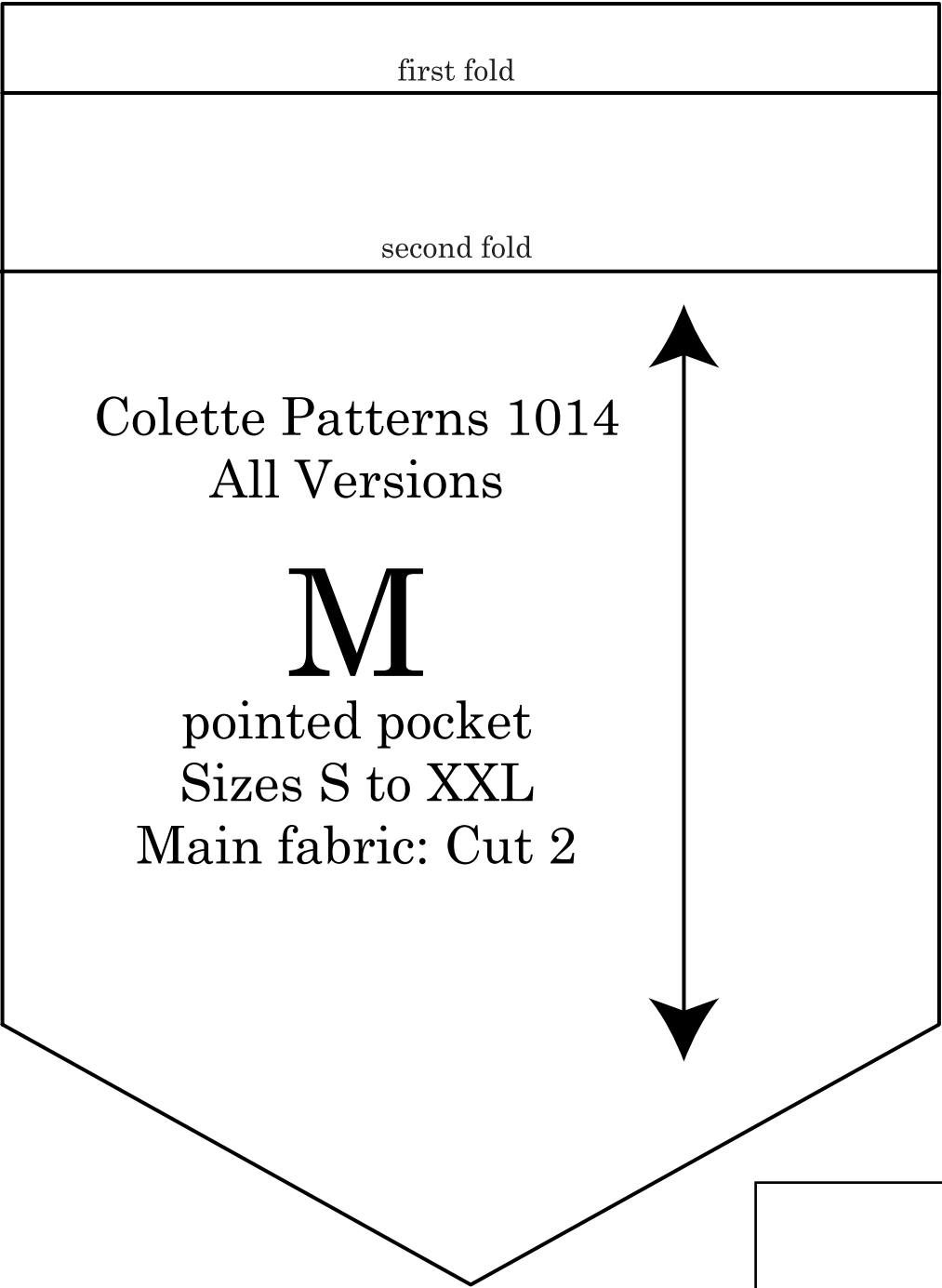

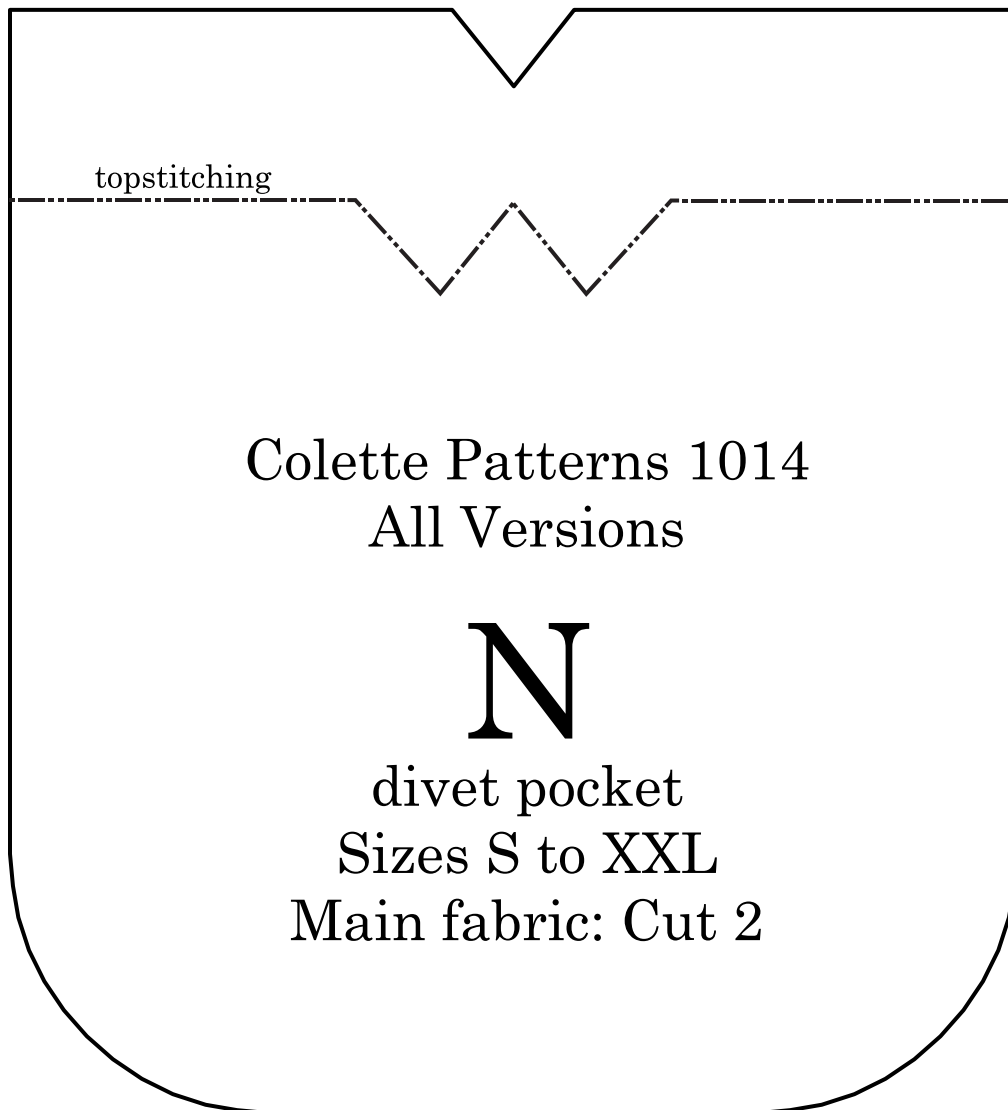
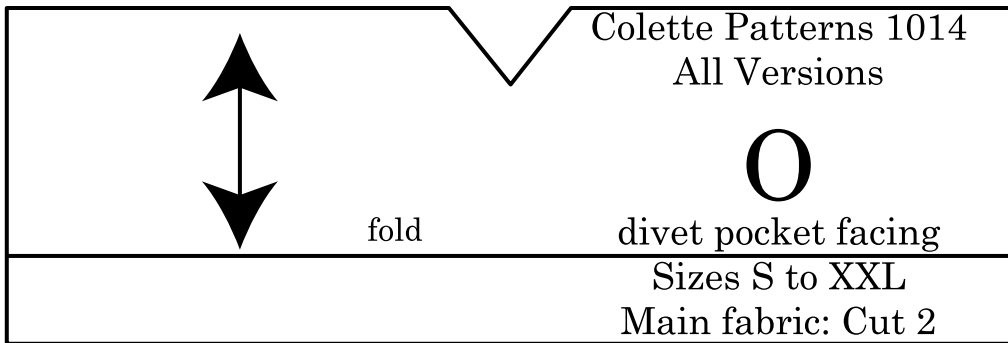

Colette Patterns 1014
All Versions

P

box pleat pocket
sizes S to XXL
Main fabric: Cut 2

